

SKKT 106, SKKT 106B, SKKH 106



SEMIPACK[®] 1

Thyristor / Diode Modules

SKKT 106

SKKT 106B

SKKH 106

Features

- Heat transfer through aluminium oxide ceramic isolated metal baseplate
- Hard soldered joints for high reliability
- UL recognized, file no. E 63 532

Typical Applications*

- DC motor control (e. g. for machine tools)
- AC motor soft starters
- Temperature control (e. g. for ovens, chemical processes)
- Professional light dimming (studios, theaters)

1) See the assembly instructions

V_{RSM} V	V_{RRM}, V_{DRM} V	$I_{TRMS} = 180$ A (maximum value for continuous operation)		
		$I_{TAV} = 106$ A (sin. 180; $T_c = 85$ °C)		
1300	1200	SKKT 106/12 E	SKKT 106B12 E	SKKH 106/12 E
1700	1600	SKKT 106/16 E	SKKT 106B16 E	SKKH 106/16 E
1900	1800	SKKT 106/18 E	SKKT 106B18 E	SKKH 106/18 E

Symbol	Conditions	Values	Units
I_{TAV}	sin. 180; $T_c = 85$ (100) °C;	106 (78)	A
I_D	P3/180F; $T_a = 35$ °C; B2 / B6	145 / 180	A
	P16/200F; $T_a = 35$ °C; B2 / B6	190 / 260	A
I_{RMS}	P3/180F; $T_a = 35$ °C; W1 / W3	200 / 3 * 140	A
I_{TSM}	$T_{vj} = 25$ °C; 10 ms	2250	A
	$T_{vj} = 130$ °C; 10 ms	1900	A
i^2t	$T_{vj} = 25$ °C; 8,3 ... 10 ms	25000	A ² s
	$T_{vj} = 130$ °C; 8,3 ... 10 ms	18000	A ² s
V_T	$T_{vj} = 25$ °C; $I_T = 300$ A	max. 1,65	V
$V_{T(TO)}$	$T_{vj} = 130$ °C	max. 0,9	V
r_T	$T_{vj} = 130$ °C	max. 2	mΩ
$I_{DD}; I_{RD}$	$T_{vj} = 130$ °C; $V_{RD} = V_{RRM}; V_{DD} = V_{DRM}$	max. 20	mA
t_{gd}	$T_{vj} = 25$ °C; $I_G = 1$ A; $di_G/dt = 1$ A/μs	1	μs
t_{gr}	$V_D = 0,67 * V_{DRM}$	2	μs
$(di/dt)_{cr}$	$T_{vj} = 130$ °C	max. 150	A/μs
$(dv/dt)_{cr}$	$T_{vj} = 130$ °C	max. 1000	V/μs
t_q	$T_{vj} = 130$ °C	100	μs
I_H	$T_{vj} = 25$ °C; typ. / max.	150 / 250	mA
I_L	$T_{vj} = 25$ °C; $R_G = 33$ Ω; typ. / max.	300 / 600	mA
V_{GT}	$T_{vj} = 25$ °C; d.c.	min. 3	V
I_{GT}	$T_{vj} = 25$ °C; d.c.	min. 150	mA
V_{GD}	$T_{vj} = 130$ °C; d.c.	max. 0,25	V
I_{GD}	$T_{vj} = 130$ °C; d.c.	max. 6	mA
$R_{th(j-c)}$	cont.; per thyristor / per module	0,28 / 0,14	K/W
$R_{th(j-c)}$	sin. 180; per thyristor / per module	0,3 / 0,15	K/W
$R_{th(j-c)}$	rec. 120; per thyristor / per module	0,32 / 0,16	K/W
$R_{th(c-s)}$	per thyristor / per module	0,2 / 0,1	K/W
T_{vj}		- 40 ... + 130	°C
T_{stg}		- 40 ... + 125	°C
V_{isol}	a. c. 50 Hz; r.m.s.; 1 s / 1 min.	3600 / 3000	V~
M_s	to heatsink	5 ± 15 % ¹⁾	Nm
M_t	to terminal	3 ± 15 %	Nm
a		5 * 9,81	m/s ²
m	approx.	95	g
Case	SKKT	A 46	
	SKKT ...B	A 48	
	SKKH	A 47	

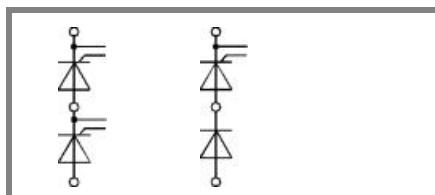

SKKT

SKKH

SKKT 106, SKKT 106B, SKKH 106

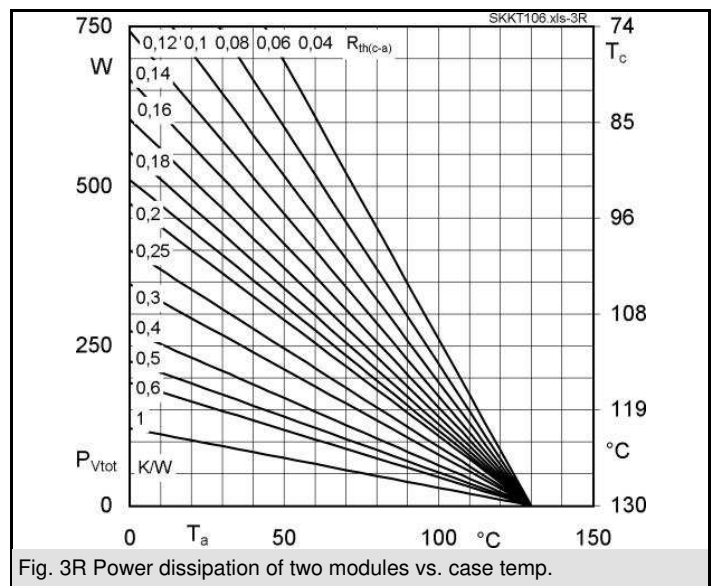
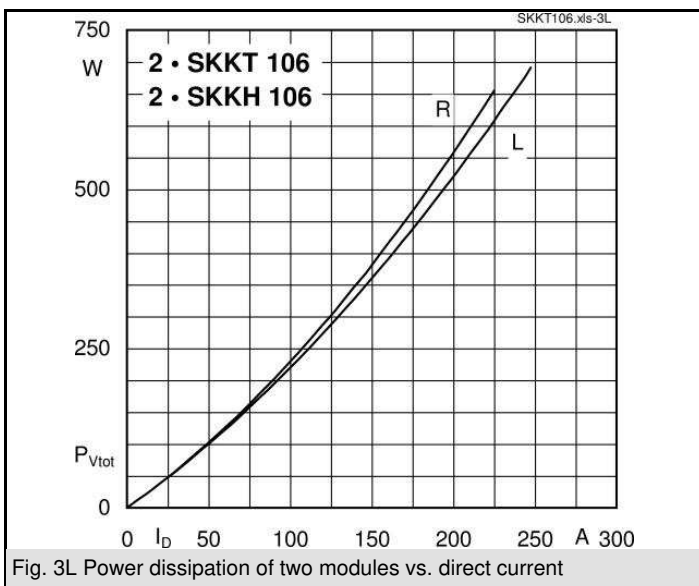
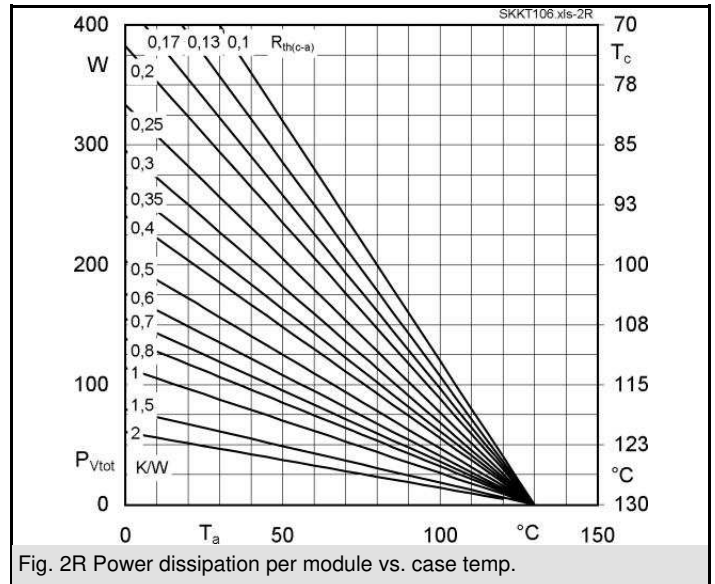
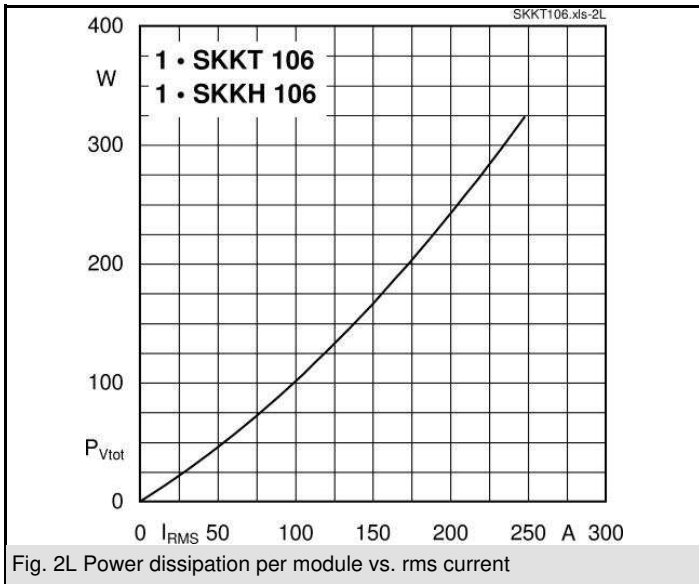
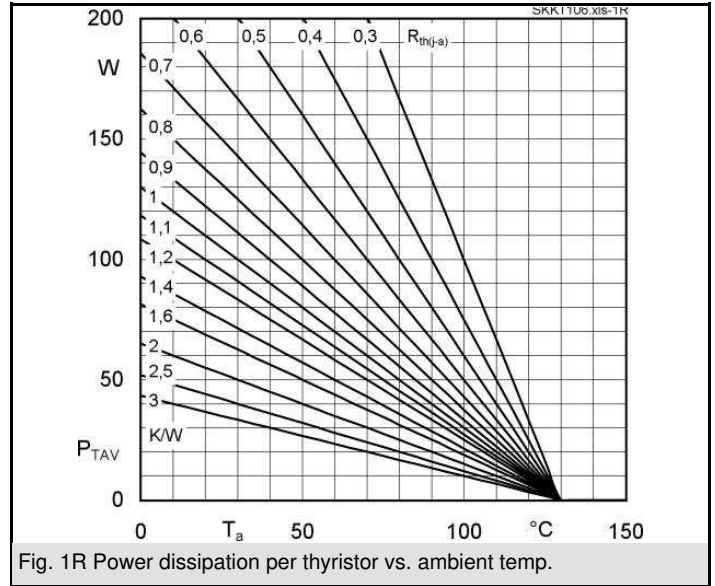
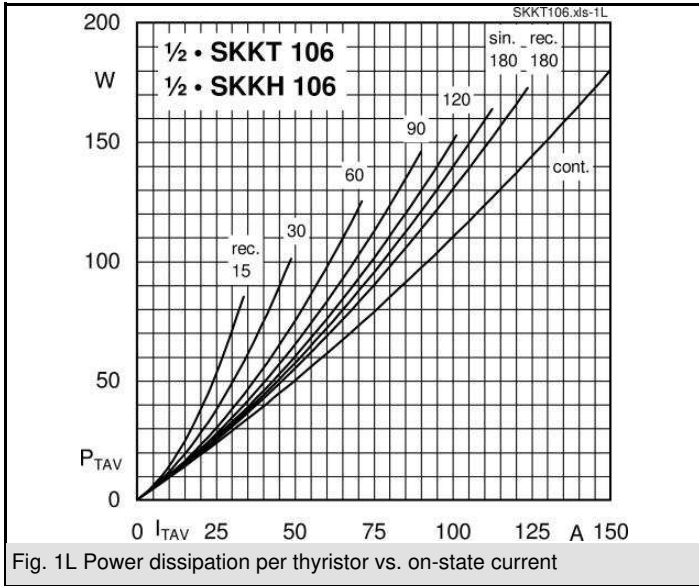

SKKT 106, SKKT 106B, SKKH 106

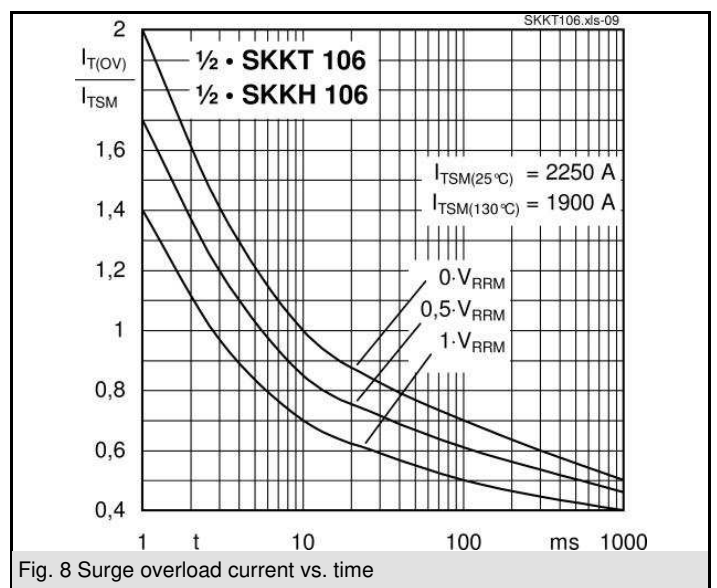
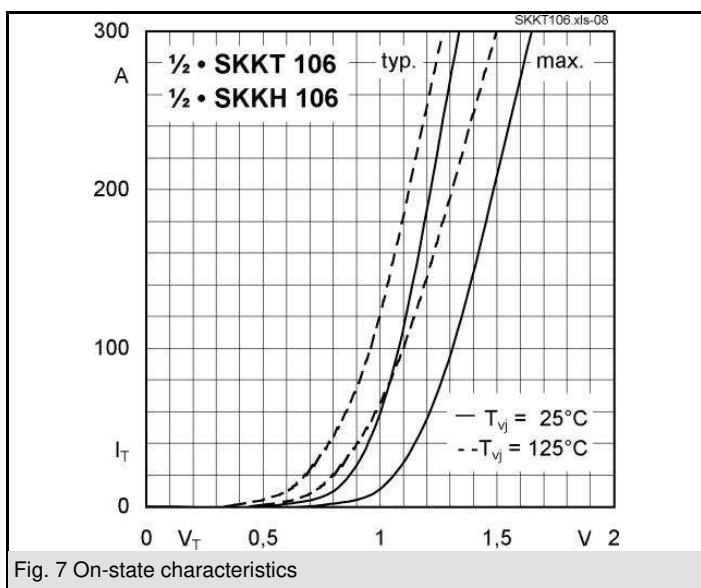
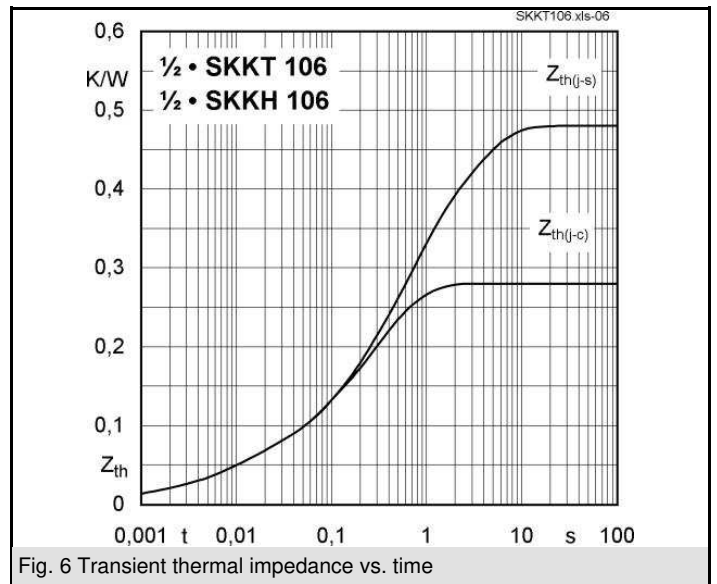
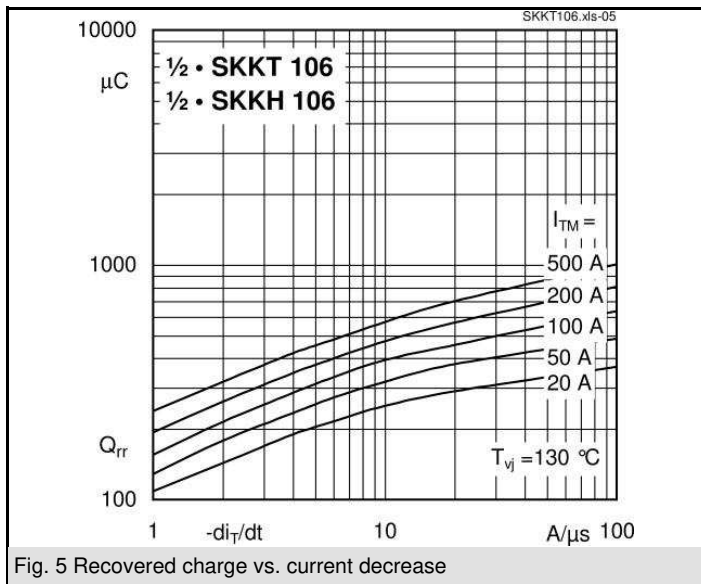
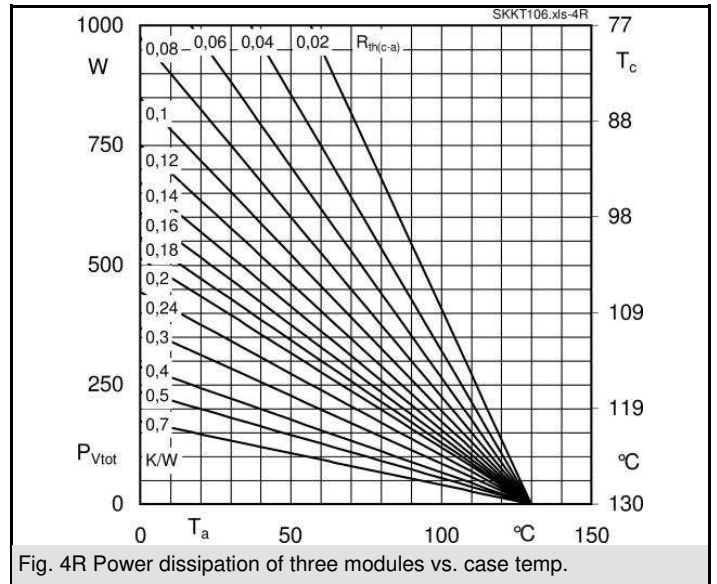
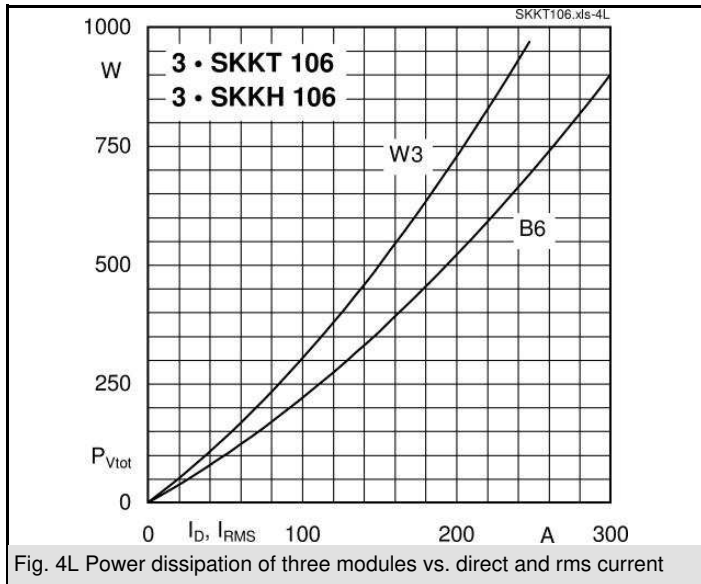

SKKT 106, SKKT 106B, SKKH 106

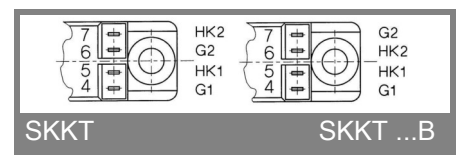
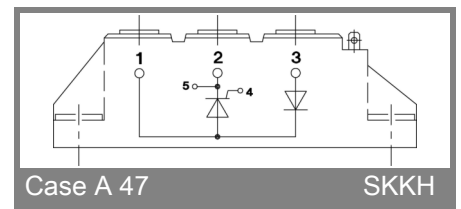
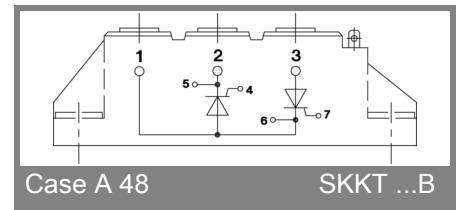
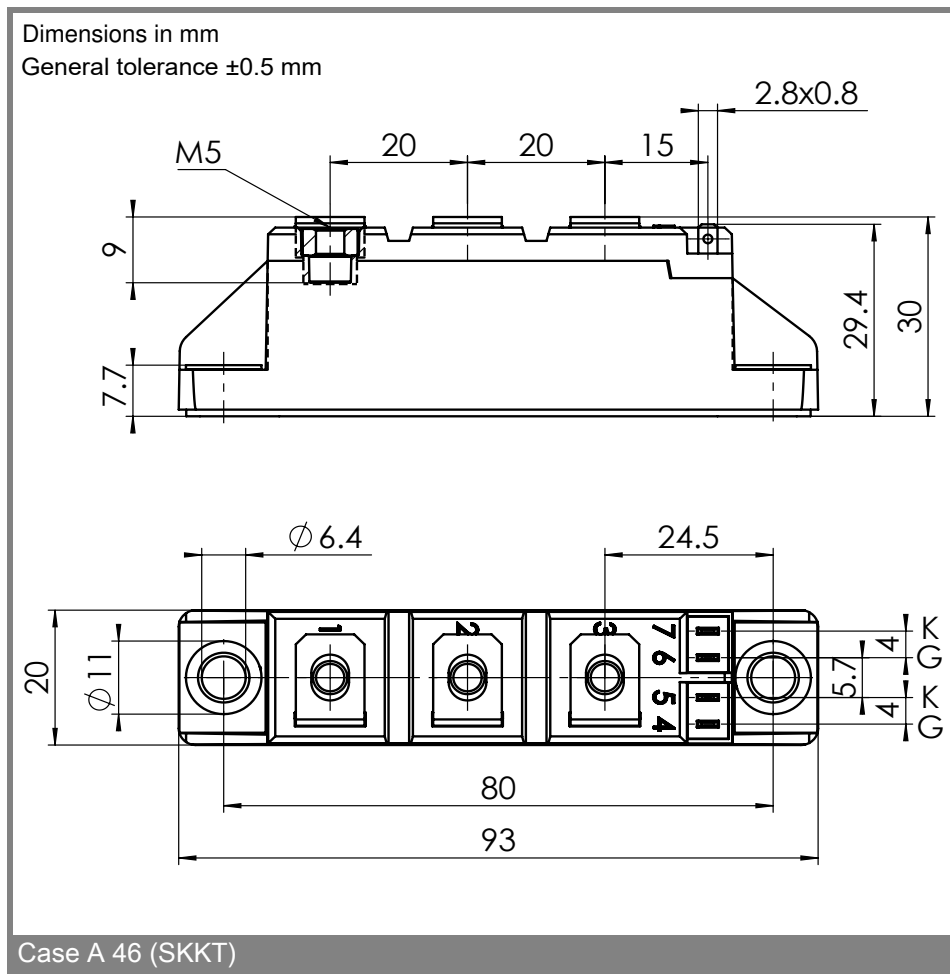
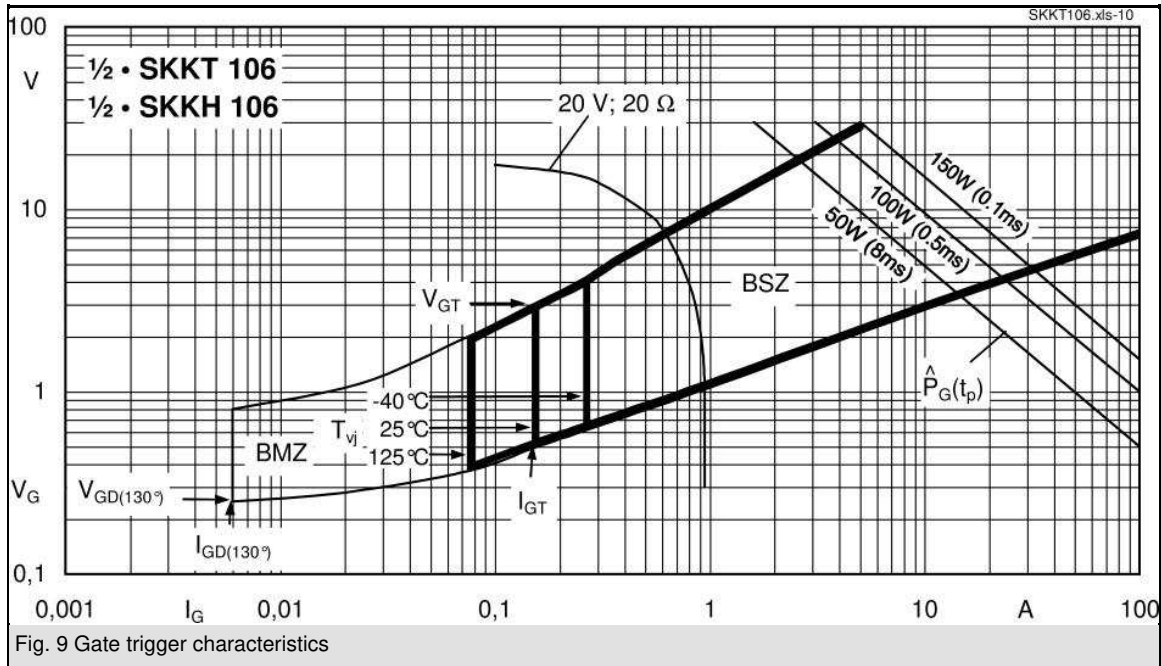

IMPORTANT INFORMATION AND WARNINGS

This is an electrostatic discharge sensitive device (ESDS) according to international standard IEC 61340.

*The specifications of Semikron Danfoss products may not be considered as any guarantee or assurance of product characteristics ("Beschaffenheitsgarantie"). The specifications of Semikron Danfoss products describe only the usual characteristics of Semikron Danfoss products to be expected in typical applications, which may still vary depending on the specific application. Therefore, products must be tested for the respective application in advance. Resulting from this, application adjustments of any kind may be necessary. Any user of Semikron Danfoss products is responsible for the safety of their applications embedding Semikron Danfoss products and must take adequate safety measures to prevent the applications from causing any physical injury, fire or other problem, also if any Semikron Danfoss product becomes faulty. Any user is responsible for making sure that the application design and realization are compliant with all laws, regulations, norms and standards applicable to the scope of application. Unless otherwise explicitly approved by Semikron Danfoss in a written document signed by authorized representatives of Semikron Danfoss, Semikron Danfoss products may not be used in any applications where a failure of the product or any consequences of the use thereof can reasonably be expected to result in personal injury. No representation or warranty is given and no liability is assumed with respect to the accuracy, completeness and/or use of any information herein, including without limitation, warranties of non-infringement of intellectual property rights of any third party. Semikron Danfoss does not convey any license under its or a third party's patent rights, copyrights, trade secrets or other intellectual property rights, neither does it make any representation or warranty of non-infringement of intellectual property rights of any third party which may arise from a user's applications.